



**KEY-LINK™**  
FENCING & RAILING

# Surface Post Mount

Powder Coated Aluminum

## Included Components

- (1) Post Mount  
(2½", 3¼", 4" sizes available)
- (4) ⅜" x ½" Set Screws

## Recommended Tools

- Safety Glasses
- Tape Measure & Pencil
- Power Drill w/ ⅜" x 5.5" bit
- Level

## Recommended Hardware

- (4) 3/8" x 5.5" Hex Head Bolt
- (4) 3/8" - 13 Hex Nut
- (4) 3/8" Flat Washer
- (1) Under Deck Bracket  
*two brackets required for corner/end*  
*(Keylink Price Book Item #940901757-11)*

## Accessories (Optional)

- Post Cap
- Post Trim
- Leveling Plate

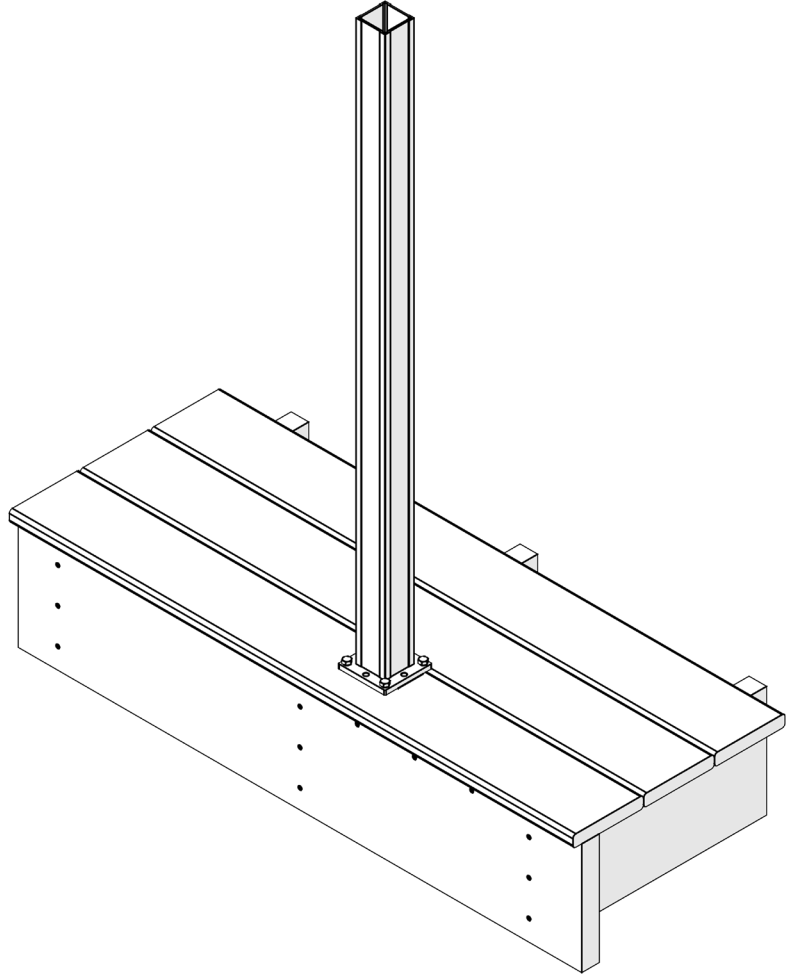

**Note:** Because building codes vary from one region to another; consult your local building codes to determine acceptable post placement and railing height.

- *These directions are only a guide and may not address every situation.*
- *Always wear proper safety equipment while assembling and installing.*
- *The installer should obtain all required building permits and follow all installation procedures in accordance with applicable building code requirements.*
- *Key-Link Fencing and Railing Inc. shall not be held liable for improper or unsafe installations.*
- *Applying paint, other than Key-Link's touch up paint, will void your warranty.*
- *To ensure proper coverage by our warranty please visit our website and complete the warranty form and mail to: Key-Link Fencing & Railing, Inc., 150 Orlan Road, New Holland, PA 17557*



WARNING: This product can expose you to chemicals including Quartz (crystalline silica), which is known to the State of California to cause cancer, and Hexavalent Chromium, which is known to the State of California to cause birth defects or other reproductive harm. For more information go to [www.P65Warnings.ca.gov](http://www.P65Warnings.ca.gov).

**Step 1:** Cut two 2" x (8" or 10") boards to fit between joists. These should be fastened together with four wood decking screws

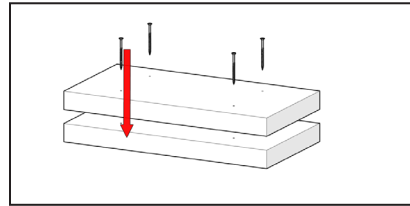

**Step 2:** Place fastened boards abutting the inside face of the outer rim joist, and flush with the underside of the deck boards.

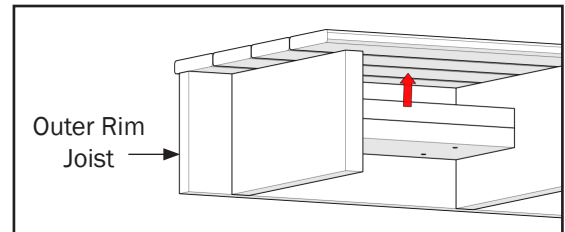

**Step 3:** Fasten each side using three wood deck screws on the bottom board, use four screws on the lower board for the front.

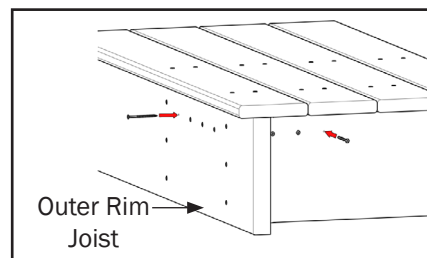

**Step 4:** Measure and mark holes for the Post Mount, specific to your post size. Use 7/16" drill bit with a shank at least 5.5" long. Keep power drill straight while drilling.

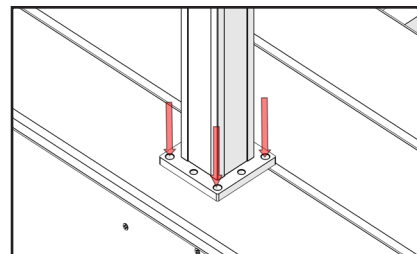

**Step 5:** Place leveling plate between post and mounting surface. Using 3/16" Allen wrench, turn set screws to level post. Use 3/8" x 5.5" Hex Head Bolts to fasten post to decking.

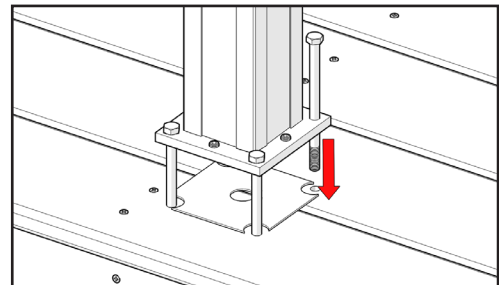

**Step 6:** Place the Under Deck Bracket over the bolt ends, parallel to outer rim joist as shown, and fasten using a standard washer followed by a hex nut. NOTE: For Corner & End Posts 2 Under Deck Brackets are required as shown

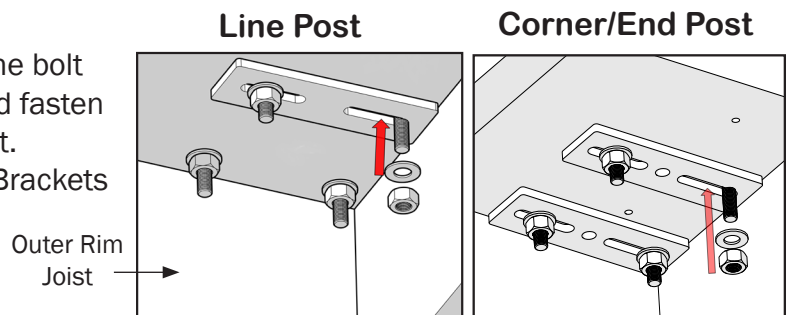

*\*In order to qualify for concentrated load safety specifications; Post Mounts must be installed exactly as specified.*

KFRIG200303