

36" and 42" Heights

# Instructions for Tuscany & Verona | Straight Rail



COLOR GUARD  
RAILING SYSTEMS

www.colorguardrailing.com

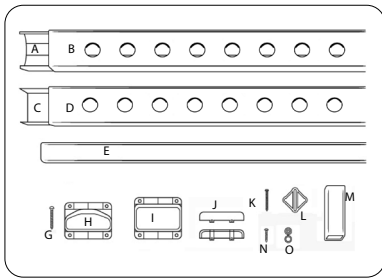

- Component List:**
- A) Aluminum Top Insert - 1 - Verona
  - B) Vinyl Top Rail 1-1/2" x 3" - 1 - Verona
  - C) Aluminum Bottom Insert - 1 - Verona
  - D) Vinyl Bottom Rail 2" x 3" - 1 - Verona
  - E) Baluster - count varies
  - G) 1-1/2" x #8 Bracket Screw - 16
  - H) Top Mounting Bracket - 2 - Verona  
(K, L, M are not included in 4' sections)
  - I) Bottom Mounting Bracket - 2 - Verona
  - J) Bracket Covers - 8
  - K) 1-1/2" x #8 Brace Plug Screw - 2
  - L) Bottom Support Block Plug - 1
  - M) Bottom Support Block - 1
  - N) 3/4" x #6 Self Drilling Rail Screw - 8
  - O) Hinged Screw Cap - 8

## Tools Required:

- Measuring tape
- Pencil
- Drill
- Phillips drive bit
- #2 Square Drive Bit
- Power miter saw
- 10" 80 tooth carbide blade
- Always wear safety goggles*

MADE IN THE USA

*Installer is responsible for quality workmanship and meeting all building codes.*

## 1 Measure Bottom Rail

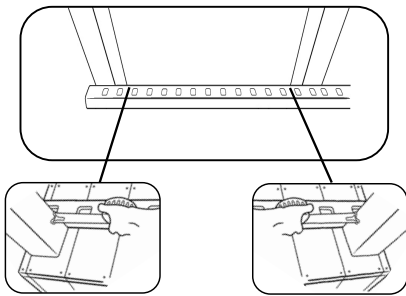

Lay bottom rail in front of post and mark rail for proper cutting on both ends.

Measure from post to edge of first routed hole, the spacing should be no less than 1 3/4". This should be done on both ends.

To provide adequate space for bracket. If less than 1 3/4" slide rail to left or right to remove a hole. This will allow for balusters to be centered and provide enough space for brackets

## 2 Cut Bottom Rail

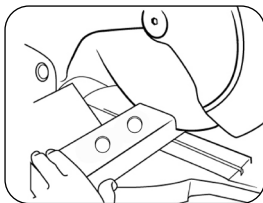

Leave aluminum in while cutting. Make first cut, then slide aluminum 1/4" in from first cut before making second cut.

**TIP:** Shortened aluminum prevents aluminum from scratching posts when installing.

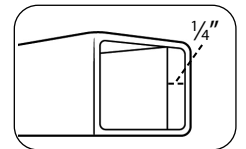

## 3 Cut Top Rail

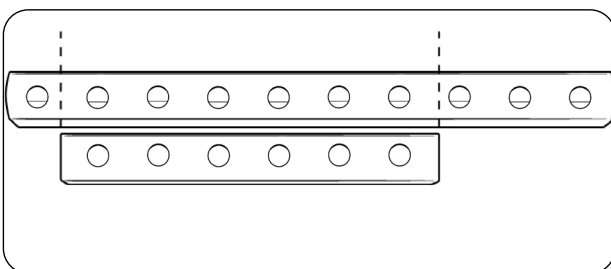

Using the bottom rail as your guide, mark the cuts of the top rail with pencil **exactly** the same as the bottom rail. This will ensure proper alignment after assembly.

Leave aluminum in while cutting. Make first cut, then slide aluminum 1/4" in from first cut before making second cut.

**TIP:** Shortened aluminum prevents aluminum from scratching posts when installing.

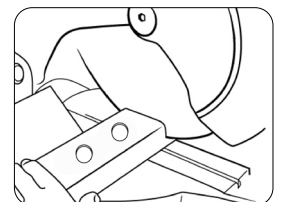

# 4

## Attach Bottom Brace Plug

(Skip this step on 4' sections)

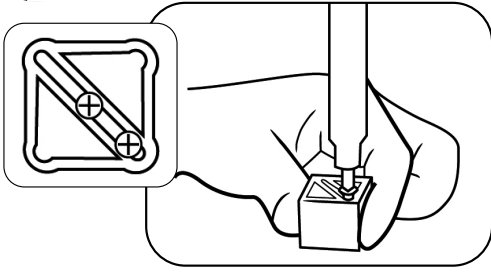

Align plug in center of bottom of the bottom rail. Be sure aluminum is centered in rail prior to securing plug to rail.

Attach plug using screws provided. The head of the screw should not be driven below slotted surface of plug.

Slide the brace onto the plug prior to installation of bottom rail.

# 5

## Attach Bottom Rail to Post

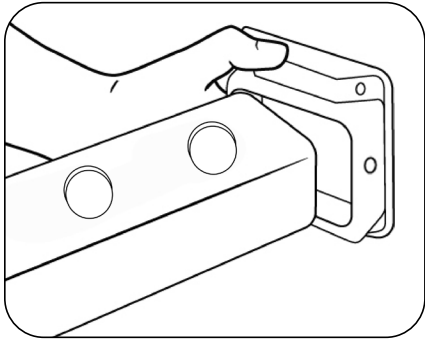

Place rail brackets on ends of bottom rail.

**TIP:** Cut 2 blocks (not included) the same size as the support block. This will support the bottom rail while securing to post.

Attach bracket and rail to post. Apply 4 screws per bracket.

**TIP:** Slightly offset bottom rail (1/16th") to start securing brackets. Screws will angle into bracket and then will center as tightened.

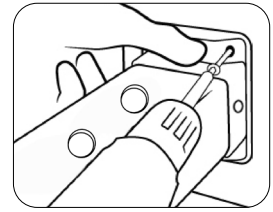
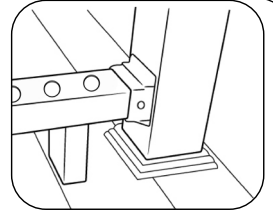

# 6

## Insert Balusters & Attach Top Rail to Post

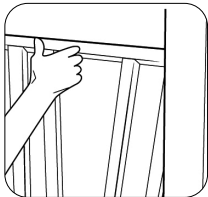

Insert balusters into bottom rail.

Starting on one end, insert balusters into top rail.

Angle balusters away from you.

Place brackets on ends of top rail.

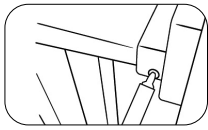

Slide rail into position. Be sure aluminum is centered to avoid scratching posts.

Screw brackets to post (See #5).

Place self-drilling screw through hinge cap. Insert cap and screw into side hole of bracket and secure. Make sure self-drilling screw penetrates both vinyl rail and aluminum insert.



Snap button cap until secure. Repeat on all top and bottom rail brackets.

Install bracket covers onto brackets. The same cover fits both top and bottom rail brackets.

