



**KEY-LINK**<sup>™</sup>  
FENCING & RAILING

# ALUMINUM RAILING







## RAILING SHOULD NEVER BE AN AFTERTHOUGHT

Railing is the first thing you see when you step onto your deck, it's essential for safety, and it literally surrounds you at every turn. Choose railing that sets the tone and matches the quality you want in the rest of your outdoor living space.

Key-Link aluminum railing is the premier choice for both residential and commercial spaces. Contractors and builders praise Key-Link's quality and the thoughtful details that make it easy to install. Home and business owners love Key-Link's unique design and premium craftsmanship.



### Manufactured in the USA

Key-Link's products are proudly designed and manufactured in the USA to ensure a quality fit and finish.

## WHAT IS KEY-LINK QUALITY?

- AAMA 2604 standard powder coating on railing and accessories to promote weatherability, with AAMA 2605 standard available for additional protection
- IBC or IRC code compliance for peace of mind and safety
- High-quality aluminum with vinyl inserts to hold balusters snugly and prevent rattling
- Limited lifetime warranty and 5-year prorated labor warranty



### Contents

Builder Brand Survey	4-5
American Series	6-9
Outlook Series	10-13
Chesapeake Series	14-17
Railing Overview	18
External Cable Fittings	19
Placid Point Lighting	20-21
Post Caps, Trim	22
Posts, Porch Posts	22
ADA Handrail	23



AMERICAN SERIES

# BRING TIMELESS LOOKS HOME

Key-Link's top-selling aluminum railing has a clean flat-top profile for a modern yet classic style. This versatile railing complements any design and can be paired with aluminum balusters or with Key-Link's horizontal or vertical cable infill for a truly custom look.







# AMERICAN SERIES

## PRODUCT DETAILS

- Level and stair rail lengths come in 6' or 8' sections
- Available in 36" or 42" heights
- Meets IRC and IBC (42" only) code requirements
- Boxed sections include top and bottom rails, mounting brackets and hardware, infill and the installation guide

\*Except Horizontal Cable

*Pictured Above:*

- a. Textured Black with Vertical Cable Infill
- b. Textured Black with Square Infill
- c. Textured Black with Horizontal Cable Infill

## PROFILE

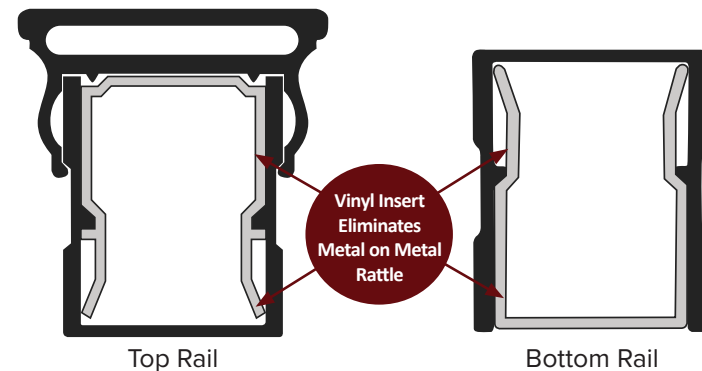

## COLOR OPTIONS



## INFILL OPTIONS

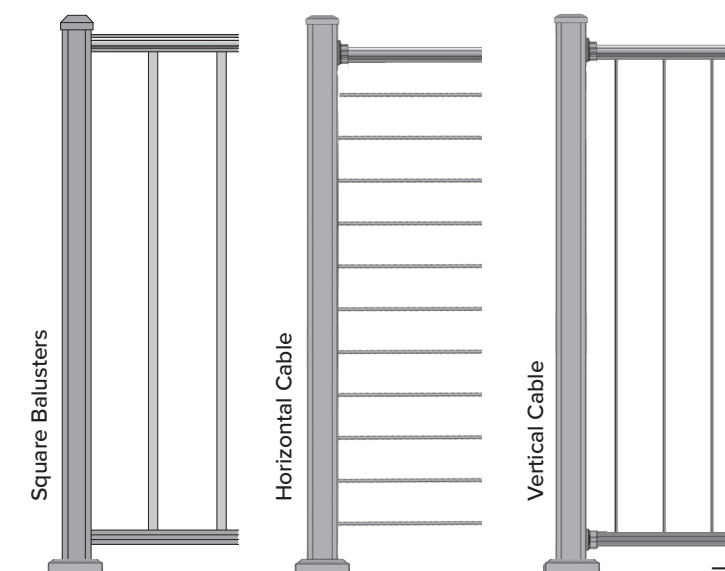



OUTLOOK SERIES

# OPEN YOUR SPACE WITH STYLE

The slim-profile Outlook railing works in small or large spaces thanks to its sleek, go-anywhere design and unobtrusive footprint. Outlook's clean lines help define and open a space, providing both security and elegance to outdoor living.







# OUTLOOK SERIES

## PRODUCT DETAILS

- Level and stair rail lengths come in 5', 6', 7' or 8' sections
- Available in 36" or 42" heights
- Meets IRC and IBC (42" only) code requirements
- Boxed sections include top and bottom rails, mounting brackets and hardware, infill and the installation guide

## PROFILE

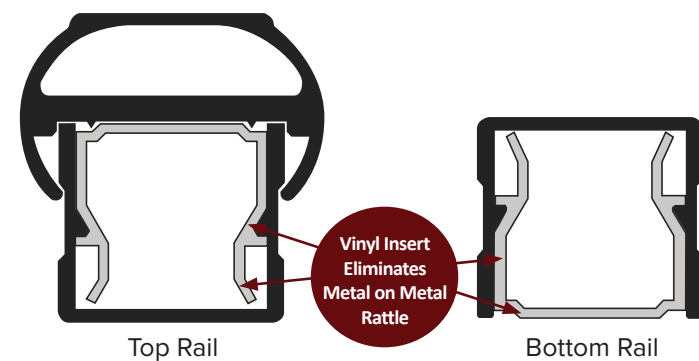

## COLOR OPTIONS



## AVAILABLE INFILL

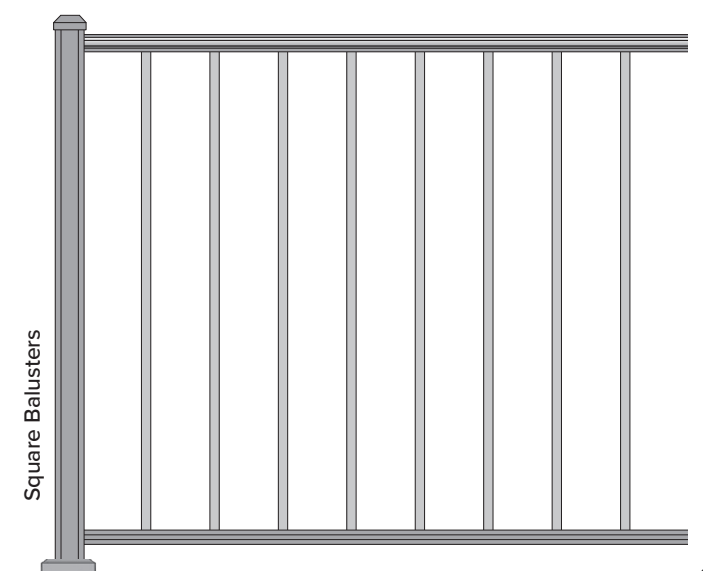

*Pictured Above:*

- a. Textured White with Square Infill*
- b. Textured Black with Square Infill*
- c. Matte Black with Square Infill*



CHESAPEAKE SERIES

# ENTERTAIN WITH ELEGANCE

This well-designed drink rail brings high-end form and function to your outdoor living. You and your guests will enjoy the convenience of having a place to rest drinks and plates, while your contractor will appreciate how quickly and easily the deckboard attaches to our specially designed profile.

Chesapeake coordinates with Key-Link's American Series for those who wish to use deckboard rail and traditional railing together.







# CHESAPEAKE SERIES

## PRODUCT DETAILS

- Level and stair rail lengths come in 6' or 8' sections
- Available in 36" or 42" heights
- Meets IRC and IBC (42" only) code requirements
- Boxed sections include top and bottom rails, mounting brackets and hardware, infill and the installation guide

\*Except Horizontal Cable

*Pictured Above:*

- a. Textured White with Horizontal Cable Infill*
- b. Textured Black with Horizontal Cable Infill*
- c. Textured Black with Horizontal Cable Infill*

## PROFILE

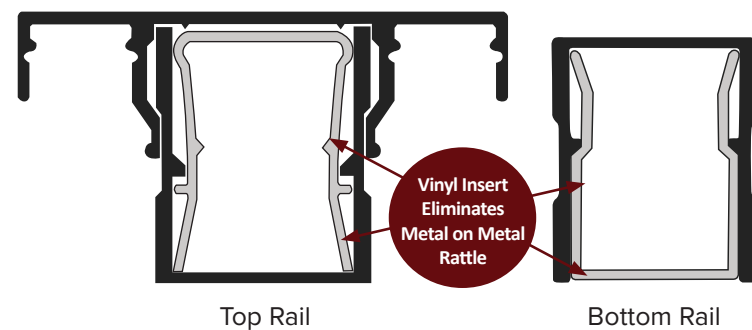

## COLOR OPTIONS



## INFILL OPTIONS

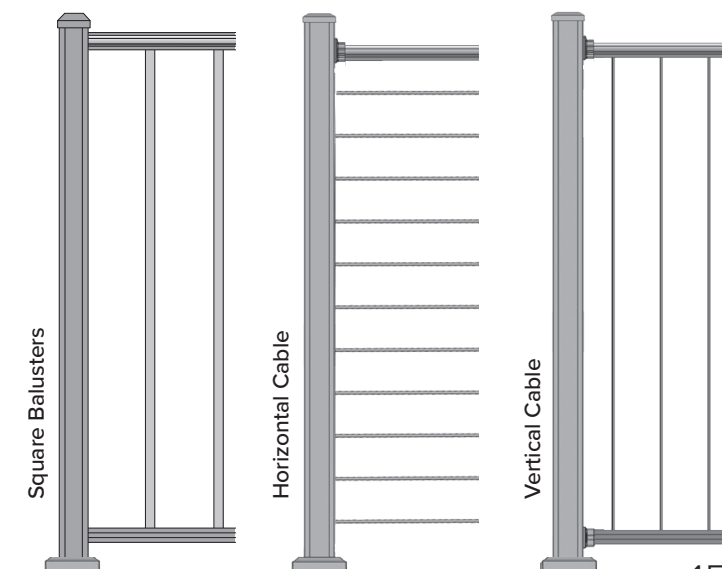





**AMERICAN SERIES**

**OUTLOOK SERIES**

**CHESAPEAKE SERIES**

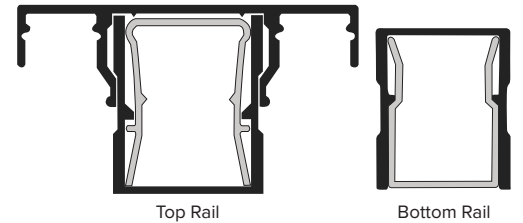
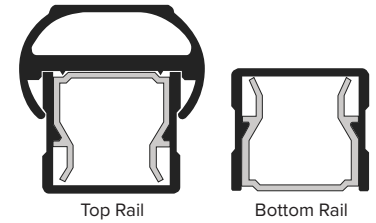
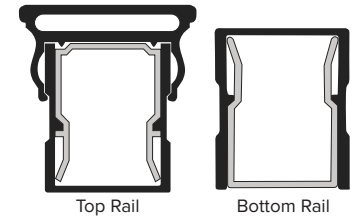

- 1 3/4" W x 1 7/8" H Flat Top Rail
- Railing Height Options: 36" · 42"
- Railing Length Options: 6' · 8'
- Square Balusters are 3/4"

- 1 1/2" Flat Top Rail
- Railing Height Options: 36" · 42"
- Railing Length Options: 5' · 6' · 7' · 8'
- Square Balusters are 5/8"

- Top Deckboard Not Included
- Railing Height Options: 36" · 42"
- Railing Length Options: 6' · 8'
- Square Balusters are 3/4"

**INFILL OPTIONS**

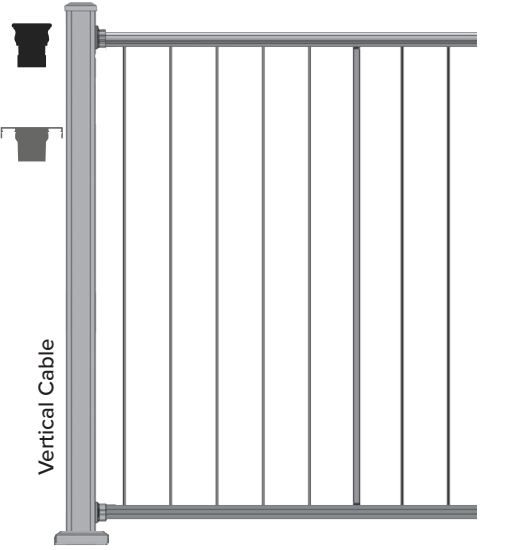
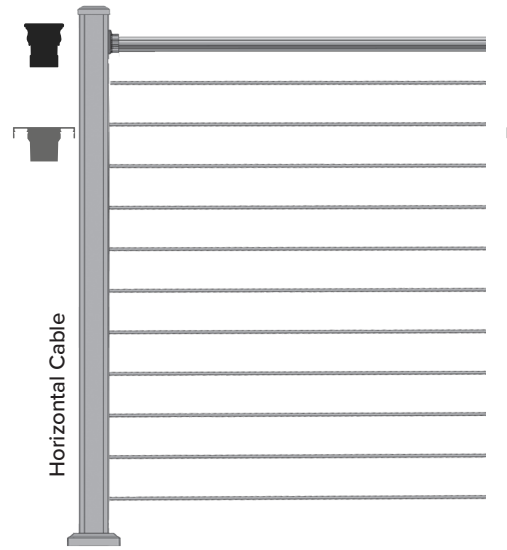
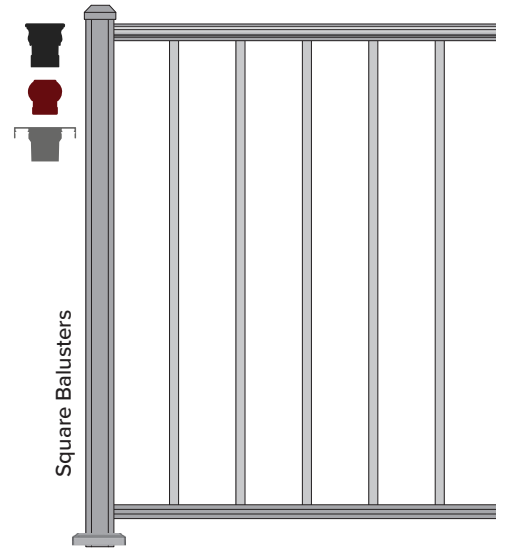

**COLOR OPTIONS**

	TEXTURED BLACK	TEXTURED BRONZE	TEXTURED WHITE	MATTE BLACK	MATTE WHITE	OIL RUBBED BRONZE	GLOSS BLACK	GLOSS WHITE	GLOSS BRONZE	GLOSS BEIGE	SILVER	KONA	BROWN-STONE	SPECKLED WALNUT	REDWOOD	HUNTER GREEN
Standard																
*Special Order																

\*Special order colors = additional charges and lead times.

Printed representations may vary from actual product color. Product colors may vary from select manufacturer's product colors.

EXTERNAL CABLE FITTINGS

**GIVE YOUR VIEW AN UPGRADE**

Cable fittings allow you to turn wood, aluminum, composite, or masonry posts into vehicles for beautiful on-trend horizontal cable railing.

These slimmed down fittings have full tensioning capacity for safety and security and require only a few standard tools for installation.

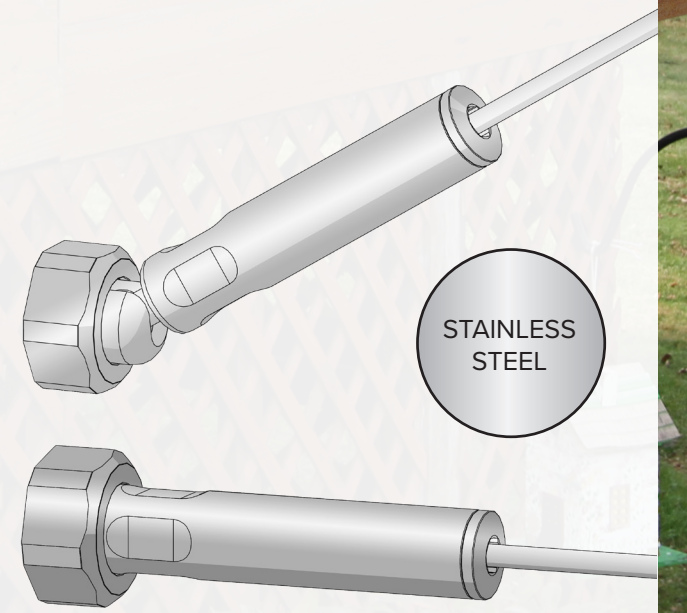

STAINLESS STEEL

Stair and level fittings available.





# BRING YOUR SPACE TO LIGHT

Create stunning focal points and add atmosphere and safety to your outdoor living space with lighting. Key-Link's lighting is designed to pair with railing for a beautiful, seamless look. Post cap and accent lights are made from diecast aluminum and powder-coated with the same coating and color, which means both posts and lights will retain their color in the same way.

Key-Link's electrical engineers and experts have refined our lights for a long-lasting and easy-to-use system that brings exceptional outdoor lighting to your deck or porch.



## COLOR OPTIONS\*

Powder-coated die-cast aluminum



## SPECIAL ORDER COLOR OPTIONS\*



## POST & ACCENT LIGHTS

Sizes available for 2½", 3¼" and 4" Posts

### POST CAP LIGHTS

3000k LED

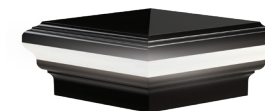

PYRAMID

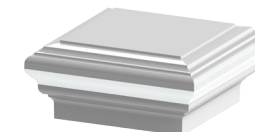

DECORATIVE

### POST CAP DOWNLIGHTS

3000k LED



PYRAMID

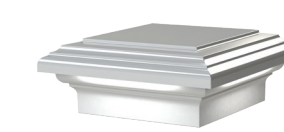

DECORATIVE

### POST & STAIR ACCENT LIGHT

3000k LED



### POST CAPS (NO LIGHTS)



PYRAMID



DECORATIVE

## LIGHTING ACCESSORIES

### LIGHTING CONTROL HUB & POWER SUPPLY



- Timer lets you choose 1-9 hours of light, or dusk-to-dawn
- Dimmer mode with 9 brightness levels
- Adjustable photocell sensor to control for ambient light
- **Walk Away** feature for safe exiting before lights go out
- Aluminum housing to match railing
- Power Supply available in 60w or Power Station

### POST LIGHT WIRE KIT

KIT INCLUDES:

- Staples
- 2-way splitter
- 5' and 9' wire extensions

### WIRE EXTENSIONS, WIRE SPLITTERS

WIRE EXTENSIONS:

- 2', 5', 9' Lengths Available

WIRE SPLITTER KITS:

- 2-Way Kit: Includes (1) 8" input cable to (2) 8" output cables
- 3-Way Kit: Includes (1) 8" input cable to (3) 10" output cables

### 2" POST ADAPTER

- Made to fit fence posts
- Fits 2" Posts
- Uses 2½" Cap for 2" Post



Product representations may vary from actual product

\*Printed representations may vary from actual product color. Product colors may vary from select manufacturer's product colors.



# WHAT'S YOUR ANGLE?

Key-Link's brackets can help take your railing in a new direction!  
 These powder coated, self-centering brackets can handle installation angles from 0-52° horizontally and 0-52° vertically, so no matter your installation challenge, Key-Link has a bracket.



## OUTLOOK SERIES BRACKETS & WEDGES



## CHESAPEAKE SERIES BRACKETS & WEDGES

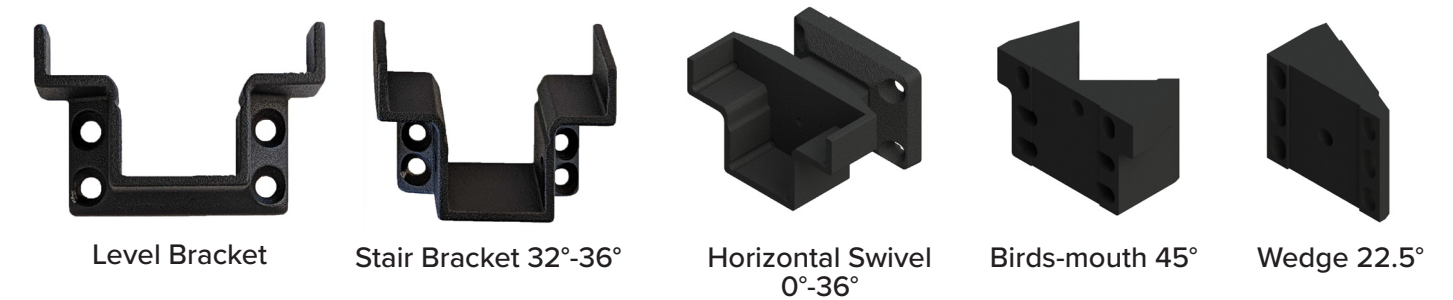

## AMERICAN SERIES BRACKETS & WEDGES



### VERTICAL BRACKET ANGLE GUIDE

Find the vertical angle you need, then note the appropriate bracket.

- Universal Swivel = 0°-52°
- Vertical Swivel = 0°-30°
- Stair = 32°-36°
- Vertical Wedge = 5°-7°

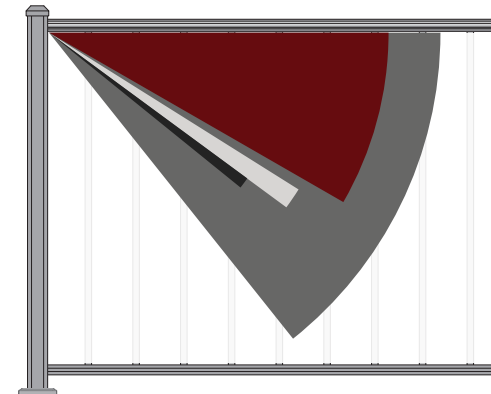

### HORIZONTAL BRACKET ANGLE GUIDE

Find the horizontal angle you need, then note the appropriate bracket.

- Universal Swivel = 0°-52°
- Horizontal Swivel = 0°-40°
- Birds-mouth = 45°
- Horizontal Wedge = 5°-7°

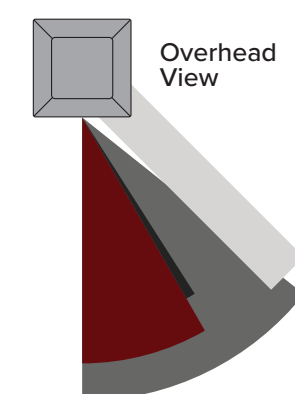



## FASCIA MOUNT BRACKETS



### STANDARD COLORS



Special order colors also available.

## POST CAPS & TRIM

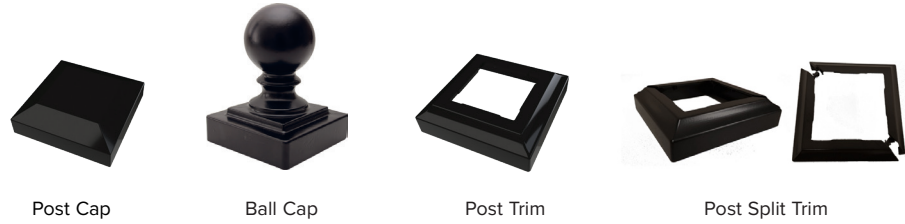

## POSTS, POST WRAP

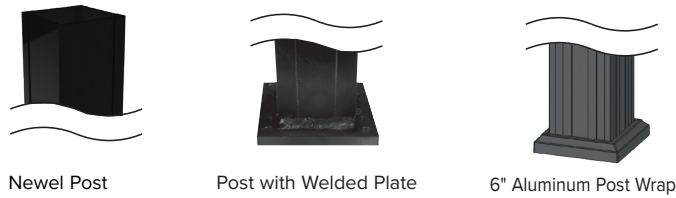

## PORCH POSTS

3 1/4" & 4" Structural Porch Posts

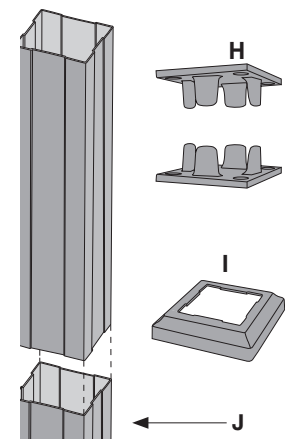

A = # 1/4" TOP & BOTTOM MOUNTING PLATES#

B = 3 1/4" POST TRIM

C = 3 1/4" x 108" POST

### STANDARD COLORS



## ADA ALUMINUM HANDRAIL

ADA Aluminum Handrail adds safety and security without compromising on looks! This handrail is designed to coordinate perfectly with Key-Link's existing railing for a beautiful, functional, and safe railing system.

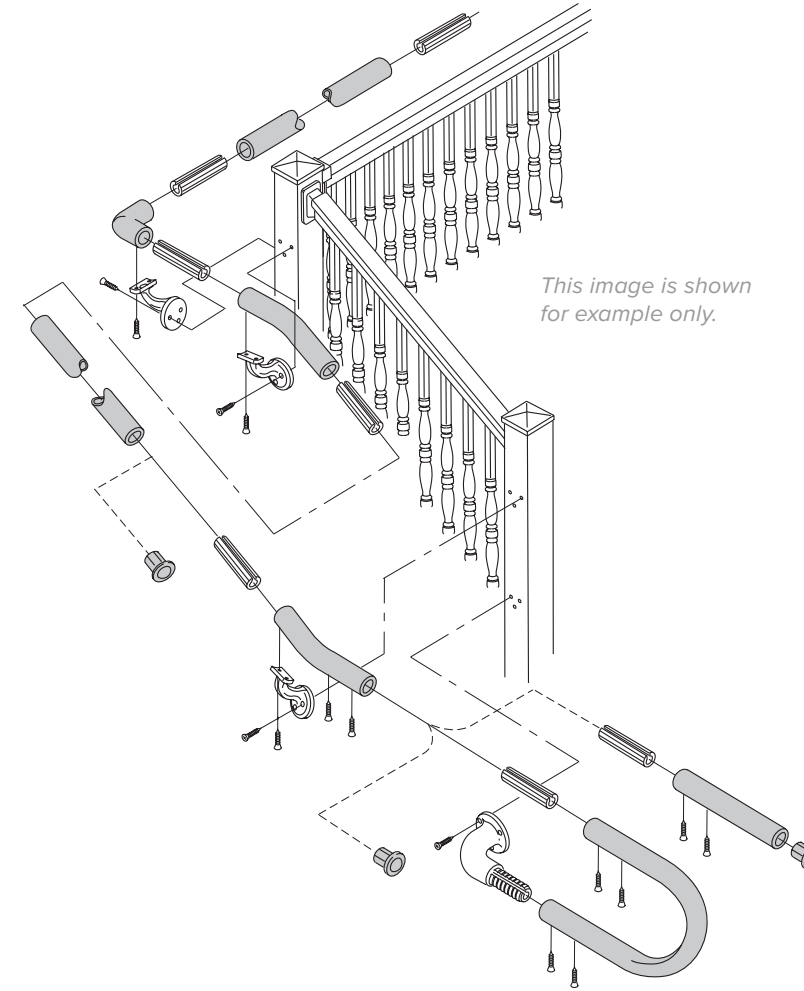

*This image is shown for example only.*

- B** END CAP
- C** P - LOOP RETURN
- D** ADA HANDRAIL BRACKET
- E** HANDRAIL CONNECTOR WITH RING
- F** 5° RADIUS ELBOW (24")
- H** 34° RADIUS ELBOW (24",
- J** STRAIGHT HANDRAIL (104")
- K** 90° RADIUS ELBOW (24")
- L** 6" CORNER MOUNTING BRACKET
- M** 0° - 90° UNIVERSAL ELBOW
- O** OUTSIDE ELBOW
- P** ALUMINUM 90° ELBOW BRACKET
- T** STRAIGHT ALUMINUM WALL BRACKET WITH RING
- U** ALUMINUM GATE RETURN (+ O)
- X** UNIVERSAL ELBOW HANDRAIL BRACKET

### STANDARD COLORS



### SPECIAL ORDER COLORS







**KEY-LINK™**  
**FENCING & RAILING**



[keylinkonline.com](http://keylinkonline.com)

260 Jalyn Drive, New Holland, PA 17557

717-355-7130 // Toll Free: 888-704-7130

Fax: 717-355-7139